

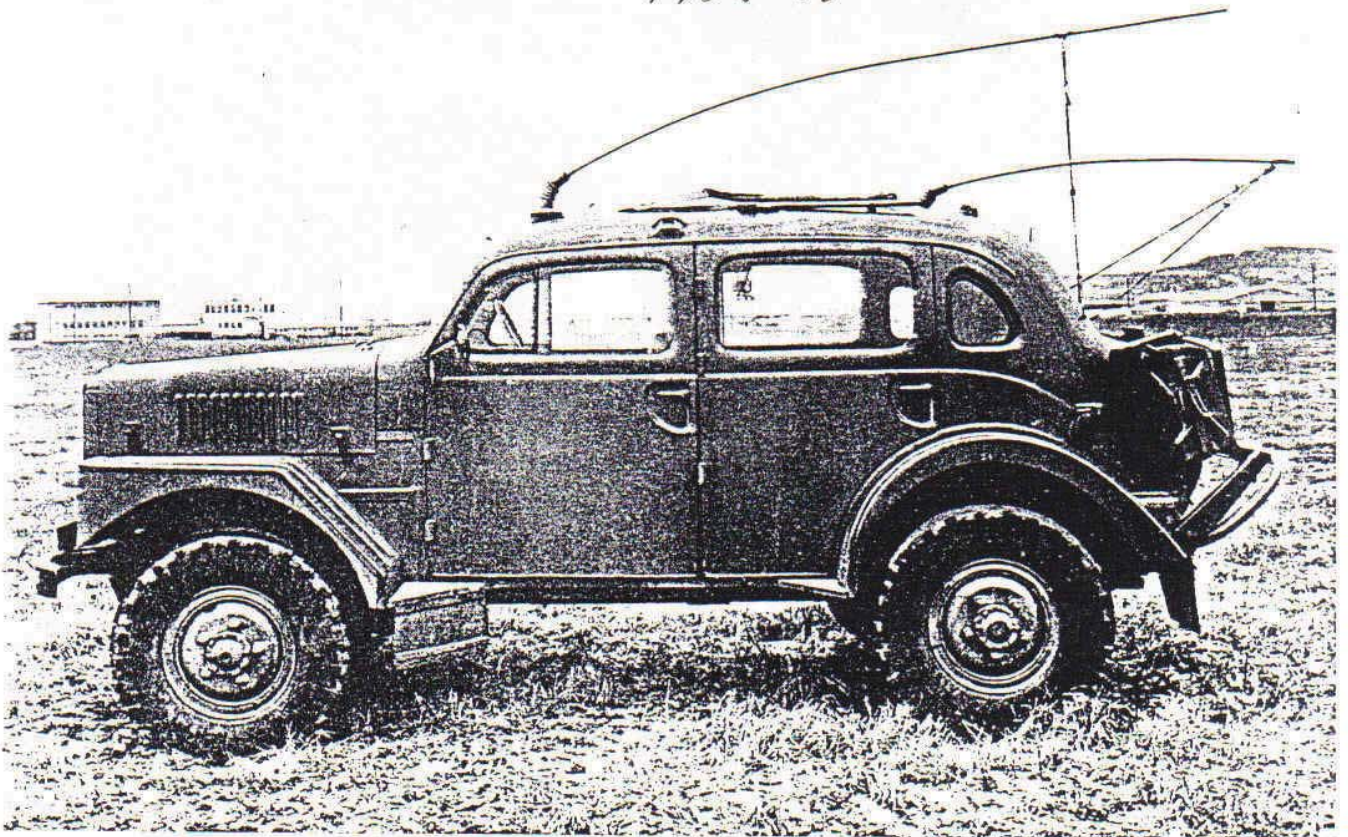

# VOLVO P 2104 "The Sow"

"Radio Personnel Carrier 915"

1953-58



P 2104 Special

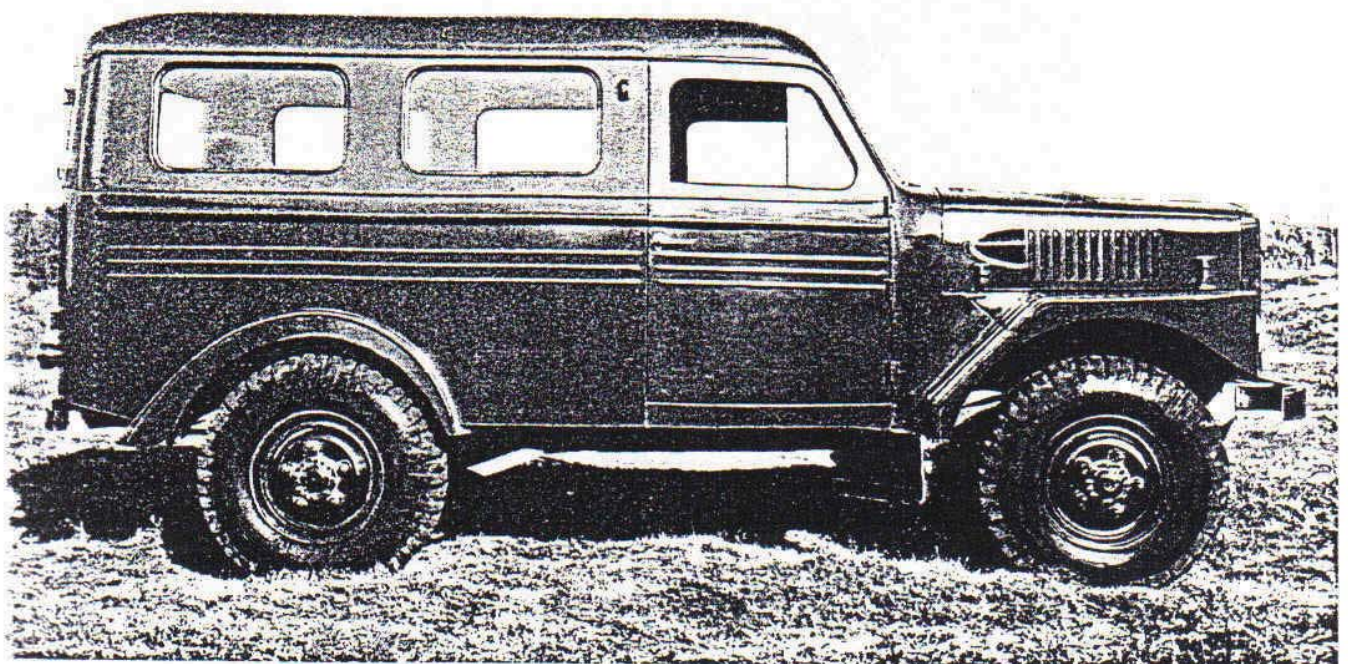









Just one model of this elegant estate car was built on a TP21 chassis under the designation of 'P2104 Special'.

tion of the Defence Forces to the terrain mobility of the TL22:

*"It was an outstanding model in that its mobility was far superior to that of any previous type. It was light, and apart from the fact that its little platform could carry only 1,500 kg, it was the one vehicle which could be relied on not only to get you there, but to get you back again!"*

A twin-axle version of the TL22 was also developed under the designation TL11 (later TL12). Designed as an auxiliary power unit (APU) for starting aircraft, the type was built only in small numbers. Apart from the smaller number of axles, the shorter frame, the open cab and the loading weights fitted to increase the

traction, the model was largely the same as the TL22 with the A6 OHV engine and an unsynchronized gearbox (the latter a challenge to later generations of military personnel who were unaccustomed to this type of unit!).

The new generation of cross-country vehicles also included the TL31, which was regarded as a 'genuine' heavy truck.

This model (which is still in service with the Swedish Army under the designation of 'Cross-country Truck 934') was developed primarily as a tractor for artillery and anti-aircraft pieces, a role in which it is still used today with its 6-wheel drive, powerful 150 bhp, 9.6 litre diesel engine (the same unit as in the Titan) and heavy-duty chassis compo-

nents. However, the capacity of the TL31 also made it useful in a number of other extremely heavy applications, and the vehicles still in service with the Swedish Army (now approximately 30 years later) are used for a variety of transport duties, although their primary task remains the towing of anti-aircraft guns and howitzers.

As in many other cases, alternative versions of these vehicles were also built in greater or lesser numbers. For example, Volvo produced an estate car known as the P2104 Special on the TP21 chassis. The TL31 has been used both as a tow truck and (equipped with the TD96AS turbo engine) as an emergency airbase fire tender.

Model - Variant	Period of manufacture	Approximate number built	Engine variant(s) (type/rating in bhp)	Approximate GVW			Remarks
				4×4	6×4	6×6	
TL11	1953-54	100	A6/105	3.500			
TL12	1956-57	165	A6/115	4.000			
TP21	1953-58	720	ED/90	2.880			
TL22	1954-59	857	A6/105-115			6.420	
TL31	1956-62	920	D96AS/150 or TD96AS/185			12.500	



**Cooling system.** Centrifugal pump with ball bearings and self-adjusting carbon seal. Distributor pipe in engine block to ensure equal water distribution and effective cooling of exhaust valves. A thermostat ensures that the cooling water normally attains its normal operating temperature. The capacity of the cooling system is 13 litres (3 Imp. galls.).

**Engine suspension.** Four well-dimensioned rubber blocks insulate the engine from the chassis.

#### CHASSIS

**Clutch.** 10" single dry-plate clutch. Springs between hub and clutch plate.

**Gearbox.** Four-speed gearbox with cover over power take-off.

Gear ratios: 1st. speed 6,65:1  
2nd. speed 3,72:1  
3rd. speed 1,82:1  
4th. speed 1:1  
Reverse 7,98:1

**Auxiliary gearbox.** Two-speed. The carrier can be run with the front wheel drive engaged or disengaged. The low gear can be engaged independent of front-wheel drive.

Gear ratios: high 1:1  
low 1,44:1

#### Speeds at 3400 r.p.m.

	I	II	III	IV
In high km.p.h.	16	28	58	105
m.p.h.	10	17½	36	65
In low km.p.h.	11	20	40	73
m.p.h.	7	12½	25	46

**Front and rear axle gears.** Hypoid gears with alternative ratios 7:36 or 6:35. The pinion lies above the centre of the crown wheel ensuring good ground clearance for the propeller shaft. The ground clearance of the gear casings is also satisfactory since the use of a hypoid gear permits the use of a crown wheel of small outer diameter.

**Front axle joints.** Power transmission to the front wheels is taken through the Rzeppa joints which allow large steering angles.

**Differential lock.** Mechanical, vacuum-operated on front and rear axles. Individual engagement of front rear axle differential locks.

**Universal joints.** Fitted with needle bearings which reduce friction and wear to a minimum.

**Propeller shafts.** Wide-angle joint tubular type.

**Frame.** All-welded with three U-profile cross members and a box-section centre cross member.

Frame member height 160 mm (6")  
Flange width 55 mm (2 5/32")  
Material thickness 4 mm (5/32")

**Steering gear.** Twin-lever Ross type. Adjustable by means of set screw. Ratio 22:18:22 to one. 18" steering wheel.

#### Springs. Front springs

Type Semi-elliptical  
Length 1025 mm (40 23/32")  
Width 50 mm (1 31/32")

#### Rear springs

Type Semi-elliptical  
Length 1200 mm (47 1/4")  
Width 50 mm (1 31/32")

**Shock absorbers.** Double-action, hydraulic shock absorbers of the telescopic type on both front and rear axles.

#### Brakes.

##### Foot brakes

Lockheed hydraulic four-wheel brakes with double wheel unit cylinders. Brake drums of chrome-alloy cast-iron with reinforcement flanges. Rubber collars round the brake drums prevent dirt and water from getting into the brakes. The brake drums are easy to dismantle. Wheel brake unit cylinders, diam. 1 1/4"

Master cylinder diam. 1 1/4"

Brake drums

Internal diam. 12"

Width of linings. 2 1/2"

##### Handbrake

Standard transmission brake

Wheels. 16x6.50

Tyres 9.00x16"

**Fuel tank.** Capacity 80 litres (17 1/2 Imp. galls.).

#### Electrical equipment.

Voltage: 12 volts

Batteries: Two 6-volt, 190 Ah batteries connected in series

Dynamo: 600 watts

Starter motor: 1,8 b.h.p.

The electrical system is completely screened to avoid radio disturbance. When the carrier is not being used as a mobile radio unit, a 6-volt system can be fitted with a battery of 114 Ah capacity, a 200-watt dynamo and a 1 b.h.p. starter motor. The battery is warmed up during operation which ensures that it is fully charged even in extremely cold weather. Extra plugs for the connection of extra batteries or to enable the battery on the truck to be used to start other vehicles.

**Standard chassis equipment.** The instrument panel is fitted with a speedometer and distance recorder, a combined instrument containing fuel gauge, oil pressure gauge and water temperature gauge, a charging control lamp, ignition switch with key and switch for instrument lighting. Tapping point for inspection lamp. The instruments are indirectly lighted and both the instrument lighting and the charging control lamp can be fitted with black-out screens. The instrument panel also contains a starting button, hand throttle, lighting switch, direction indicator switch with indicator lamp and there is a locker on the right-hand side. The foot-dipper switch is on the toe-plate. There is a defroster and heater unit. Built-in headlights with parking lights. Two combined stop and tail lights.

Mudguards, bumpers. Windscreen wipers.

Spare wheel. Tool kit and powerful hydraulic jack.

#### DIMENSIONS AND WEIGHTS

Chassis weight	about 2000 kg (4409 lb.)
Weight with 5-seater body	about 2600 kg (5732 lb.)
Weight with 2-man cab and platform	about 2500 kg (5511 lb.)
Gross laden weight	3200 kg (7055 lb.)
Load	700 kg (1543 lb.)
Wheelbase	2685 mm (105 3/4")
Track, front	1550 mm (61")
Track, rear	1600 mm (63")
Overall width	1900 mm (75")
Overall height at cab	about 1950 mm (77")
Overall length	about 4500 mm (177")
Turning circle diameter	about 12000 mm (471 1/2")
Max. tow hook tractive effort	about 2000 kg (4409 lb.)

The factory reserves the right to alter the design and equipment.

**AKTIEBOLAGET VOLVO**  
**EXPORT DEPARTMENT**  
**GOTHENBURG - SWEDEN**



# Raptgbil 915

Detaljerade anvisningar ingår i beskrivning del I (F 570-1);  
där angivna intervaller gäller dock icke.

Mekaniker hänvisas till beskrivning del II (F 570-2).

Nr	Smörjställe	An- tal	Var 150 mil*	Var 300 mil*	Var 1500 mil**	*Dock minst en gång var tre månad **Dock minst en gång vartannat år			Nr			
						Var 1500 mil**	Var 300 mil*	Var 150 mil*				
12	Styrstog	2							1	Styrväxelhus	16	
13	Parallellstog	2							1	Kylvätkepump Två pumpslag	17	
13	Framhjulstet Anm 3	2							1	Framaxelväxel	18	
11	Fördelare Anm 2	1							1	Luftrenare Gör ren	19	
10	Oljerensare Anm 1	1								1	Motor	20
9	Pedalaxel	1							1	Uppkopplings- lager Två pumpslag	21	
8	Tryckluftsa- behållare	1							1	Handbromsväxel	22	
7	Kopplingsaxel Två pumpslag	2							1	Växellåda	23	
6	Kardanknut med glidskarv	7							1	Fördelnings- växellåda	24	
5	Fjäderbult	4							1	Hastighets- mätarvojer	25	
4	Kardanknut utan glidskarv	3							2	Dragåkr	26	
2	Bakaxelväxel	1								ledar, länkar, gångjärn, lös m m	27	
1	Fjäderhänke	8										

## Teckenförklaringar

- Motorolja DG 10W/20 vid alla temperaturer  
DG 20W/30 ned till ca -10°C
- Transmissionsolja MP 80 vid alla temperaturer  
MP 90 ned till ca -10°C
- Fordonsfett MP, tryckluft- eller handfettsspruta
- Fordonsfett MP, handfettsspruta
- Tunn motorolja, oljekanna
- Bromsvätska 430
- Övrigt, se anmärkning
- Kontroll av nivå
- Byte av olja

## Rymduppgifter

Motor (vexhus och oljerensare)	7 l
Växellåda	4 l
Fördelningsväxellåda	3 l
Framaxelväxel	3,25 l
Bakaxelväxel	
i o m chassinummer 220	3,25 l
fr o m chassinummer 221	5,5 l
Styrväxelhus	0,5 l

## Anmärkningar

1. Var 150:e mil, tappa ur för-  
orenningar (i o m chassinummer  
220). Var 3:e oljebyte, byt  
filter.
2. Gånga in smörjkoppens hast-  
mutter 1/2 varv. Fyll på spe-  
cialfett, Bosch eller likvärdigt,  
vid behov. Smörj krytarkam-  
mens centrumhål med ett par  
droppar motorolja.
3. Kontrollera oljeläckning.



# Volvo P 2104

The Volvo P 2104 is a light four-wheel driven chassis, to be fitted with a 4-5 seater body. It can also be fitted with a special body for seven passengers or with a two man cab and short platform.

## SPECIFICATIONS

### ENGINE

#### Carburettor engine ED

Number of cylinders	6
Valves	Side
Output	90 b.h.p. at 3600 r.p.m.
Bore	84.14 mm
Stroke	110 mm
Cylinder capacity	3.65 litres
Compression ratio	6.5:1
Torque	22 kgm (159 lb. ft.)

Cylinder block of special-alloy cast-iron. Cast integrally with crankcase.

Cylinder head. Specially designed combustion chambers for high compression.

Pistons of chill-cast light-alloy, fitted with three compression rings and one oil control ring. The upper ring is chromed to reduce cylinder wear.

Connecting rods. I-section, forged and toughened, drilled longitudinally for gudgeon pin lubrication.

Crankshaft. Drop-forged, statically and dynamically

balanced. Seven main bearings. Total bearing surface 136 cm (21 sq. ins.).

**Bearing shells.** The connecting rod bearings and the main bearings are fitted with replaceable, babbitt-lined steel shells.

**Camshaft.** Drop-forged with case-hardened, ground cams and bearings. Supported in babbitt-lined steel bushings. Driven by a toothed chain for silent running. Guided axially by a spring-loaded support pin.

**Valves.** Inlet valves of nickel-steel. Exhaust valves of chrome-nickel alloy-steel for protection against lead-tetraethyl fuel.

**Ignition.** Battery ignition with high-output ignition coil.

**Fuel system.** Rochester down-draught carburettor with manual choke, set for good fuel economy when the throttle is partially open and excellent output when the throttle is fully open. Thermostatically-controlled pre-heating of the fuel-air mixture. Mechanical fuel pump of A.C. manufacture. Air filter of the oil bath type with splash protector for cross-country operation.

**Lubricating system.** Crankshaft and camshaft bearings and gudgeon pins are pressure lubricated by a generously dimensioned, gear type pump. The pump, which has a built-in relief valve, is accessible from the outside. Floating-type oil strainer. Highly-efficient oil filter helps the oil maintain its self-cleaning properties. Lubricating system capacity 7 litres (12 1/4 Imp. pints). Deep wet-type oil sump.

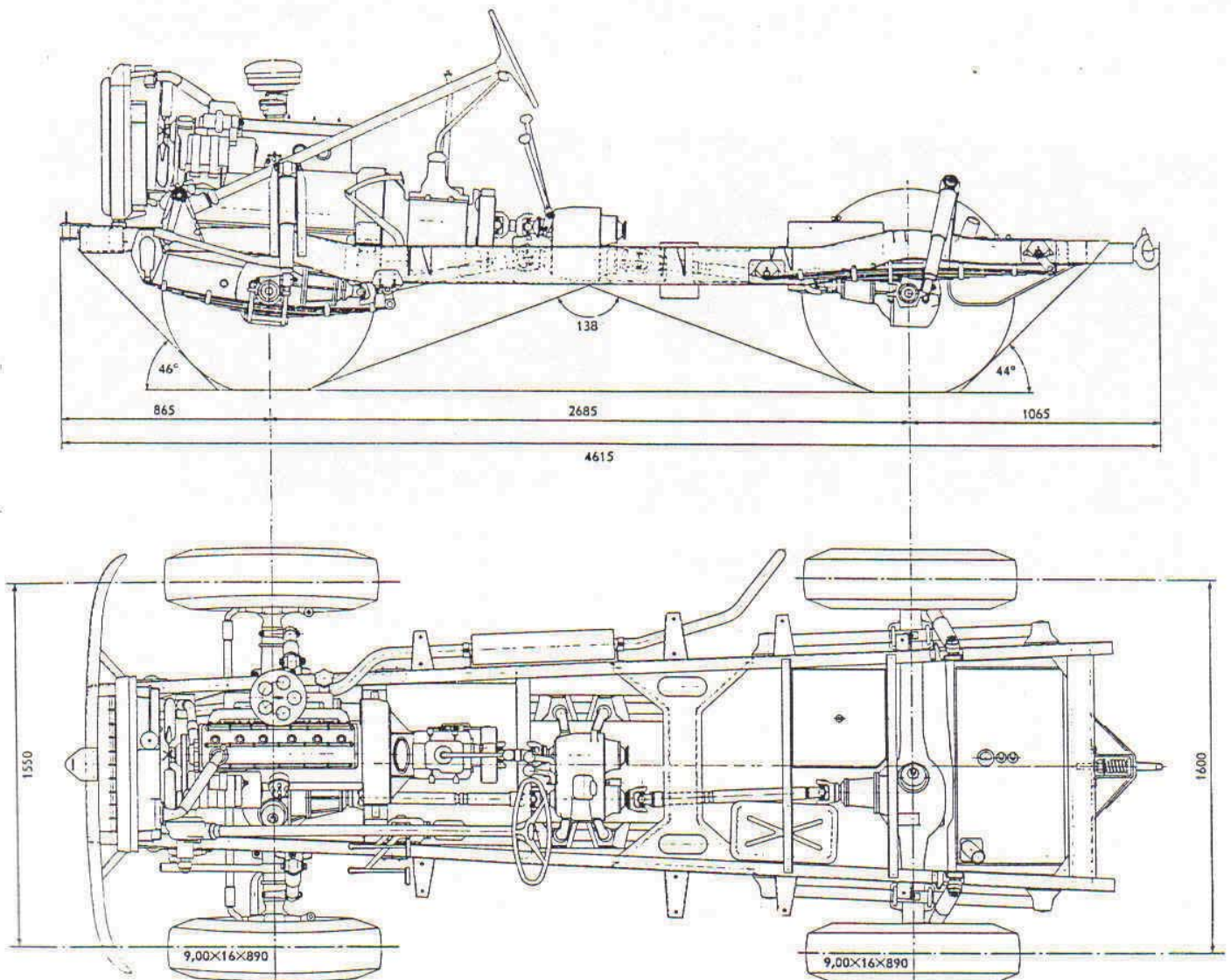



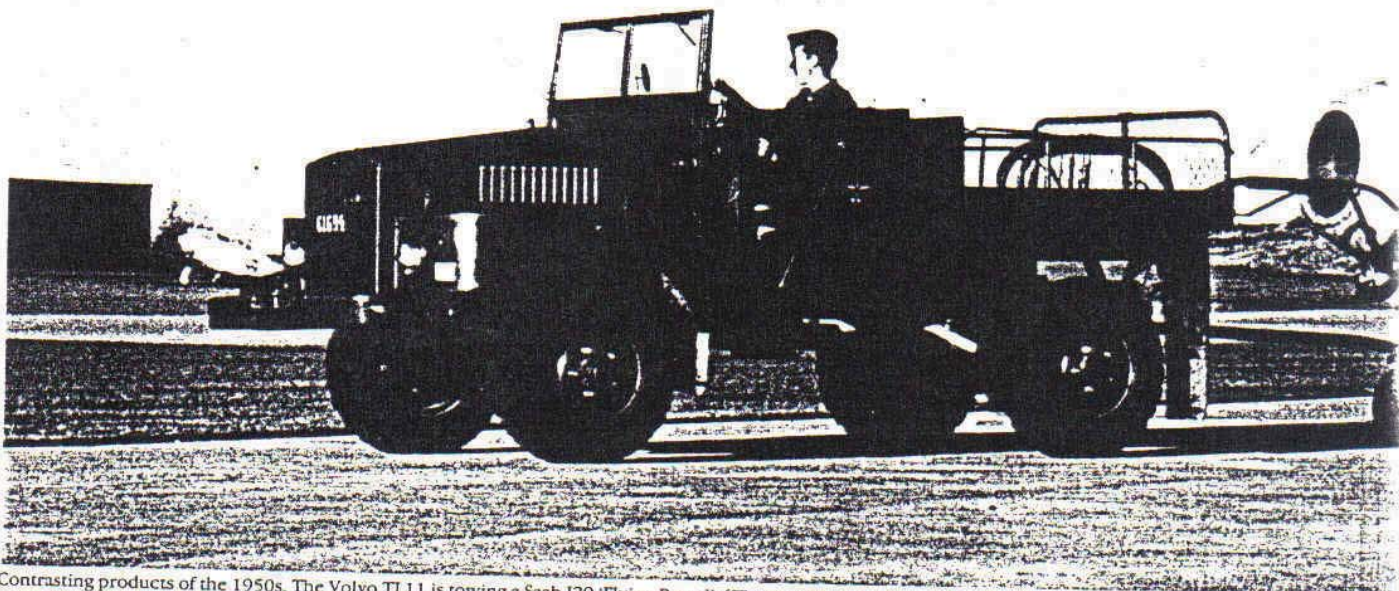

Contrasting products of the 1950s. The Volvo TL11 is towing a Saab J29 'Flying Barrel'. (The aircraft was also equipped with a Volvo engine built by Volvo Flygmotor in Trollhättan.)

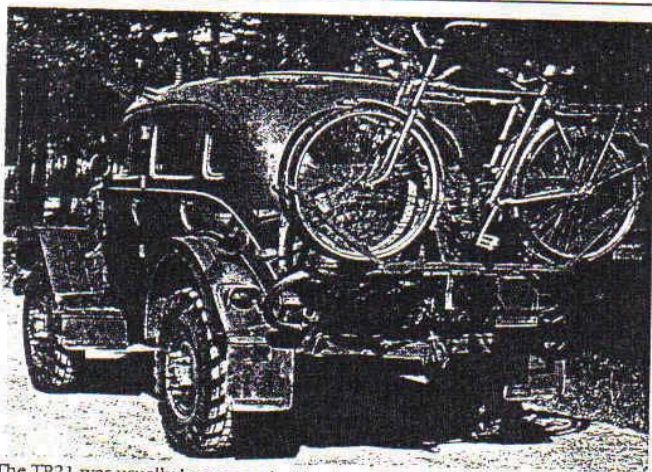

The TP21 was usually known as the 'Sow', a nickname which reflected the resemblance of the rear end to a pig! In this photograph, it is seen transporting one of the commonest means of transport then used by the Swedish military - bicycles.

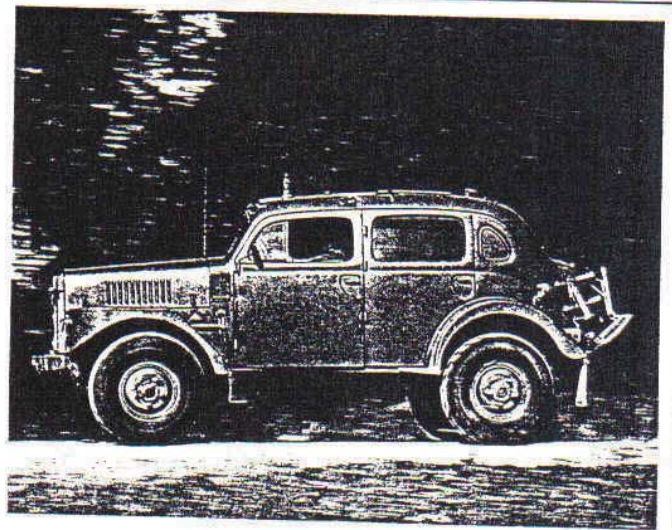

comfortable staff transport. However, as a relatively exclusive and expensive model which was produced only in small numbers, the TP21 (or 'Radio Personnel Carrier 915' as it was known by the military) proved unsuitable for export to countries requiring a simpler type of vehicle.

Equipped with the Volvo 90 bhp, side-valve, 6-cylinder, ED engine, the TP21 was of an extremely straightforward

mechanical design.

The next of the new generation was the TL22 (or TL21 as the prototypes were known). This was the first of the true, light cross-country vehicles built by Volvo - models which were later developed into the small, forward-control, all-wheel drive military trucks. The TL22 (military designation 'Cross-country Vehicle 912') was actually a fairly small model capable of carrying only about

1,500 kg on its metal platform, despite its three driven axles and its massive appearance. Its outward resemblance to the TP21 (at least at the front) was its only similarity with its predecessor. Equipped with an extremely rugged frame, a 105 (later 115) bhp OHV engine and a service weight of 4,200 kg, the model was ideal for cross-country and troop-carrying operations.

Måns Hartelius has described the reac-



DATA

TYPE MILITARY	RATCAR 915
TYPE VOLVO	TP 21
Length overall	4,70 m
Width	1,90 m
High (antennas down)	3,00 m
(roof top)	2,15 m
Clearance	0,25 m
Turn diameter	12,00 m
Axle base	2,73 m
Track gauge (front)	1,57 m
(rear)	1,60 m
Overhang (front)	0,86 m
(rear)	1,06 m
Tyres	9,00-16 in. 10 plies
Tyrepress.	2,4 kg/cm <sup>2</sup>
Vehicle id number	Front left side of chassisframe
Engine number	Left side of engine
Gearbox number	Left side of gearbox
Dist.gearbox number	Top side of dist. gearbox
Rev. and Fwd. gear number	On gearhousing
Max nr of passengers (except driver)	3 pieces



DATA CONT.

Dutyweight with driver and equipment

2880 kg

Max press. on rear axle

1470 kg

ENGINE.

Type

ED

Output at 3600 rpm

22 kgm

Number of cylinders

6

Cylinders diameter

84, 14 mm

Stroke

110 mm

Cylinder vol.

3670 cc/223 cu.in.

Valvearrangement

Sidevalves

Firing order

1-5-3-6-2-4

Timing

0-2 degrees before tdc.

Fuelpump type

AC diaphragmpump

Carburator type

ROCHESTER-B7004475

ELECTRIC EQUIPMENT

Coil

BOSCH-ZS/KAM 12/1

Distributor

BOSCH-ZV/JAM 6 AL 1

Spark plug

AC 45 or equivalent

Battery type

M 2672-010010

Voltage

12 V

Kapacity

190 Ah

Ground pole

Negative

Generator

600 W BOSCH



Electrical equipment cont.

Starting engine 1,8 hp 12V  
Charging regulator (early models) BOSCH-RS/KK 600/12/1  
(late models) BOSCH-RS/WAK600/12/1  
Fuse 80 amp BOSCH-WSG 512/7X

Electrical bulbs	nr. of	Watt
Headlights	2	45/40
Parkinglights	2	2
Blackoutlights	1	15
Pos. lights	1	8
Map light	1	15
Turn signals	2	15
Back-up light	2	15
Brake light	2	15
Rear searchlight	1	25
Reg. plate light	1	5
Pos.rear light	2	3
Diff. lock controllamp	2	2
Turn sign. controllamp	1	2
Charging controllamp	2	2
Rear searchlight controllamp	1	2

Fuse box is located on left side of firewall in enginecompartment

Fuses 8A, BOSCH-WSG 501/1

Fuse box index are stamped on the fuse box lid.



CAPACITIES.

Fuel tank (main tank) 76 liter  
(aux. tank) 10 liter  
Cooling system 13 liter  
Engine with oilfilter 7,0 liter  
Gearbox 4,0 liter  
Dist. gearbox 3,0 liter  
Front axle 3,25 liter  
Rear axle (until vehicle id. nr. 220) 3,25 liter  
(later than 220) 5,50 liter  
Steering gear 0,50 liter

MAX SPEEDS.

	LOW GEAR	HIGH GEAR
1 st gear	10 km/h	15 km/h
2 nd gear	15 km/h	25 km/h
3 rd gear	35 km/h	50 km/h
4 th gear	65 km/h	90 km/h



INSTRUMENTATION.

1. Instrument light dimmer
2. Rear light controllamp
3. Rear light switch
4. Fuel gauge
5. Long beam controllamp
6. Speedometer
7. Oil pressure gauge
8. Fresh air intake button
9. Turn signal controllamp
10. Light separator
11. Blackout light switch
12. Defroster control
13. Heater engine switch
14. Diff. lock handle, front axle
15. Diff. lock controllamp, front axle
16. Diff. lock controllamp, rear axle
17. Diff. lock handle, rear axle
18. Temperature gauge
19. Signal horn
20. Ignition switch
21. Charging controllamp
22. Turn signal switch
23. Headlight switch
24. Hand gas regulator
25. Choker handle
26. Start switch
27. Chain for radiator curtain
28. Foot switch for headlights
29. Brake pedal
30. Clutch pedal
31. Steering wheel
32. Gear shifter
33. Parking brake handle
34. Speeder
35. Hi/lo gear shifter
36. 2/4 wheel drive shifter
37. Voltage gauge
38. Hand gas regulator
39. Charging controllamp
40. 12V output
41. Wireless main switch





Bild 4. Manöverorgan



7. 986

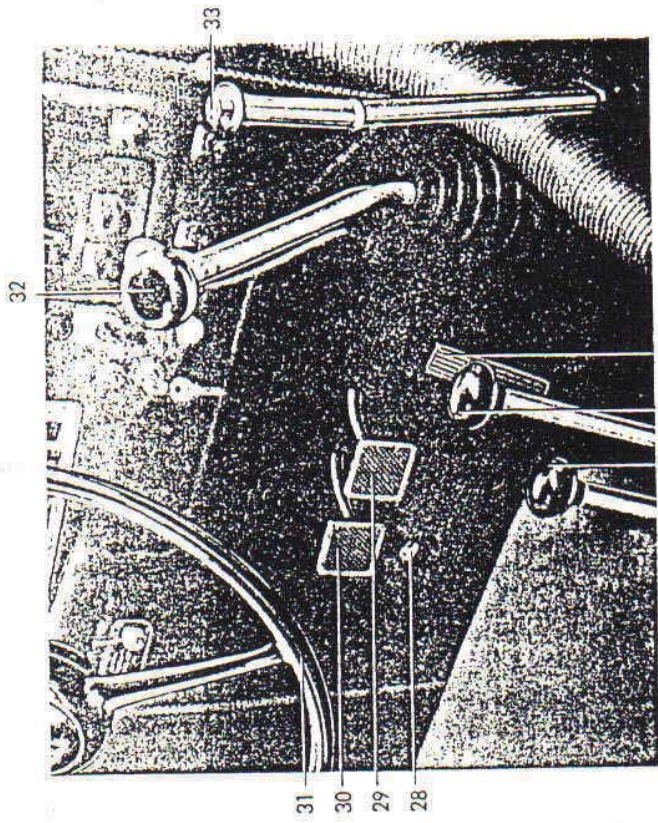
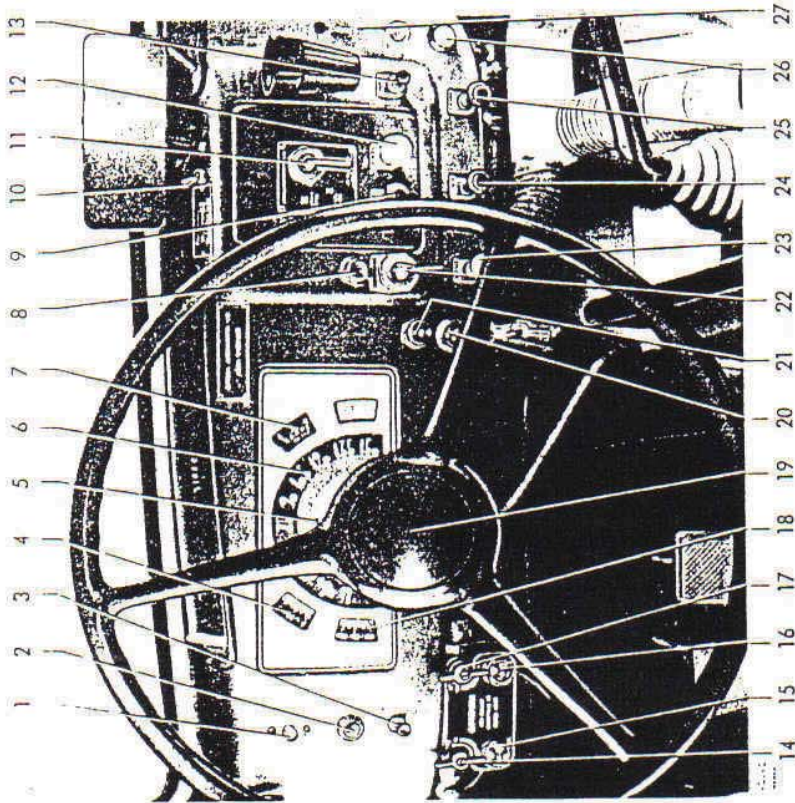
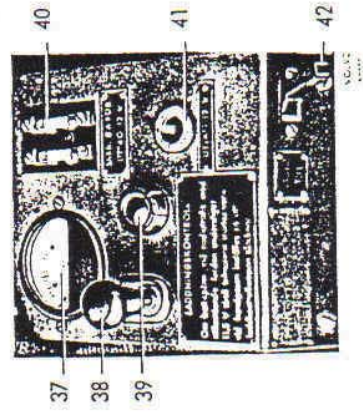

## Manouvering rods.

There are three manouvering rods in the drivers compartment:

- A gear shifter for the four speed transmission.
- A manouveringrod for two- or four wheel drive.
- A manouveringrod for high or low gearbox.

The gears position are shown on a sign placed on the gearboxhood.

## Oilpressuregauge.

The oilpressuregauge are placed in the right side of the dashboard and is showing the pressure in the engines lubrication oil system.Theoilpressure are depending of engine rpm. the temperature in the engine, and the viscosity of the oil.

The pressure are normally 1,5-2.5 kg/cm<sup>2</sup> when the engine is hot.If the oilpressure should drop below 1 kg/cm<sup>2</sup> when the engine is running,you must stop the engine at once, and find thecause of the pressure drop before the engine is restarted.

## Fuelgauge.

Thefuel gauge are placed in the left side of the dashboard. The fuelgauge does not show any capacity before the ignitionkey have been turned.

## Temperaturegauge.

The temperaturegauge are placed in the left side of the dashboard and shows the temerature in the engines cooling system and the working temperature. The temperature should be kept at 80 C. The temperature must never drop below 70 C for longer piriods as it could cause heavy wearings in the cylinders.

## Radiator curtain.

The coolants temperature is guided by a thermostate ,but the car is equipped with a radiator curtain.Please use it when the weather is cold..You can adjust the length of the curtain by pulling the chain placed on the left side of the glovecompartment.

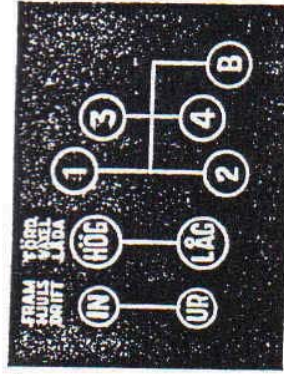



Ignition switch.

The ignition is turned on by turning the ignition key clockwise.

Charging controllamp.

The charging controllamp are placed over the ignition switch. During driving the lamp is normally out, which shows that the generator are charging. When the lamp is on, the generator are discharging. If the lamp is on during driving, something is wrong in the electrical system.

Turnsignal controllamp.

The controllamp is flashing when any of the turn signals are on.

Lightswitch with controllamps.

The parkinglight and headlightswitch is marked "LJUS" and is placed in the middle of the dashboard. It's got three positions:

Late models: When pressed in all lights are out. Halfway out the parkinglight is on. When the switch is pulled all the way out all lights are on

Early models: When turned to the right parkinglight is on, next step to the left the lights are out, the next step to the left, all the lights are on.

The switch for the long beam is placed on the floor to the left of the clutch pedal, control-lamp is in the dashboard. The instrumentlights are dimmed with a switch on the left side of the dashboard. The different positions for the blackout switch are marked on a sign under the switch.

To prevent that lights should be turned on during blackout a lightseparator is placed in the middle of the dashboard. The rear searchlight switch is placed to the left (early models to the right) of the dashboard. When the light is on, a blue controllamp is on.



Diff. locks with controllamps.

The diff. locks are operated with two handles placed just beside the steering wheel tube.

To operate the diff. locks the handles should be moved to a horizontal position.

When the locks are engaged, two controllamps are lit just under the handles.

The lamps can be dimmed by turning the glasses on the lamps.

Instruments for wireless.

The wireless dashboard are equipped with voltage gauge, handgasregulator, and charging-controllamp, two 8 amp. fuses for 12V output, and switch for wireless. In case of sending with the wireless with the engine stopped, it must be restarted when the voltage gauge drops below 11.5V, and the handgas should be set, so that the chargingcontrollamp is out.

**NOTE! THE HANDGASREGULATOR SHALL BE PUSHED IN DURING DRIVING AT ALL TIMES.**

Fuel tank selector.

Just in front of the right front seat on the floor. When the selectorcock is pointing at "H" the main tank is on, and on aux tank when the selectorcock is pointing at "R".



DIFF. LOCK HANDLES



## MAINTENANCE AND DRIVING.

### Enginestarting:

a. Pull out the choke, full or partly, if the engine is cold.

If the engine is warm, you do not need to use the choke, just press the gaspedal down, and never pump the pedal, or the engine "drowns".

b. Put the pedal to the metal.

c. Turn the ign. key clockwise, the charging controllamp will now be on.

d. Press the start switch, let go the switch as soon as the engine have started.

e. If you have used the choke to start the engine, you must push it in again until you have reached the best idle speed. When the engine is warm the choke must be pushed all the way in.

f. Check the oilpressure (1,5-2,5 kg/cm<sup>2</sup>).

NEVER REV THE ENGINE JUST AFTER A COLDSTART.

NEVER DRIVE HARD BEFORE THE ENGINE IS HOT.

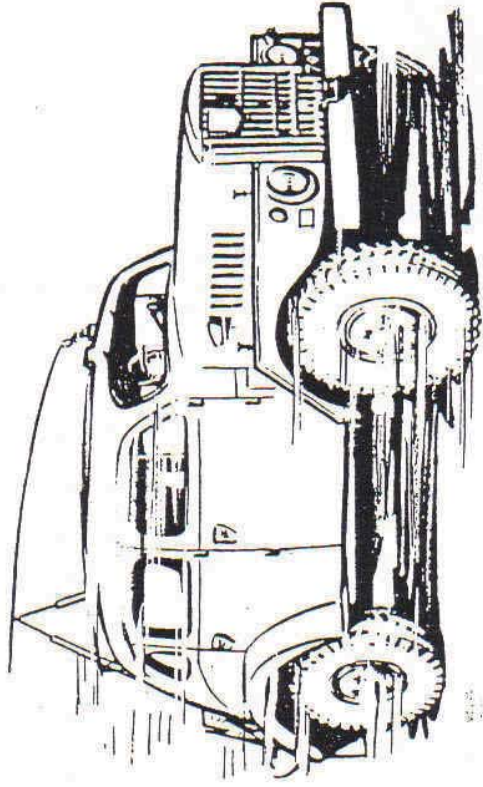



## HOW TO JUMP START.

If the batteries are flat, so that the vehicle will not start, you can take an extra battery (12Volts) and connect it to the jumpstartpoles.

If wires are drawn from an other vehicle,remember to connect pos-pos, neg-neg.

NOTE! make sure that both vehicles are equipped with 12V.

## DRIVING.

Never drive faster than the mission requires.

Never exceed the max speeds in any gear, while driving downhill, or the engine will be damaged.

Use only two wheel drive under normal circumstances.

The four wheel drive is only to be used where two wheel drive are insufficient,for instance slippery roads or in the country.

Use the high gearbox while driving on the road, the low gearbox should be used while driving in the terrain.

The diff locks are only to be engaged in slippery fields. you will engage the rear lock first, and only the front lock if it is absolutely necessary.

You will find out that steering the car is very difficult.

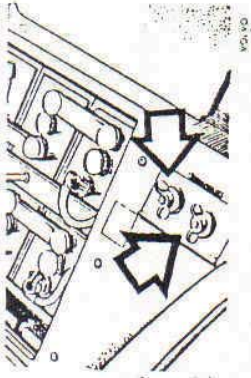

## JUMPSTART CONNECTION



### SHIFTING THE GEARS.

There are four gears for forward driving, and one for reverse. Shifting from a low to a high gear are normally done with doubleclutching, without speeding up the engine. When going from a high to a low gear, you take the gear stick in neutral, then press the speeder, press the clutch down, and shift down.

Four wheel drive can be engaged during driving, just remember that the engine must never pull, or brake the vehicle while shifting. Please note that steering will get heavier.

Shifting between high and low gearbox should be done at very low speed, or preferably at standstill, taking care of that the dist. gearbox is unsynchronized. The wheels must not spin while engaging the diff. locks.

### THE HEATER.

During winter driving, the fresh air intake should be open at all time. That is done by pulling the fresh air handle out. The fan is started by turning the "heat" switch on.

If you need to defrost the windshield, pull out the "vindr." handle and open the vent, windows a little.

If you wish to get fresh air in the vehicle in the summertime, you just turn the hot water circulation cock off, and follow the instruction above.

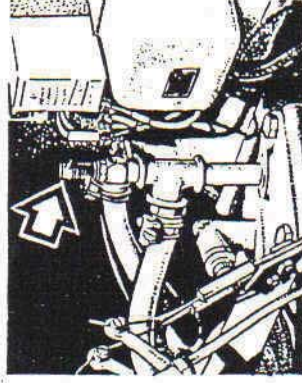

HOT WATER  
CIRCULATION COCK



#### FRONT SEAT.

The front seat can be adjusted forward or reverse by the handle (1) to the left. Make sure that the seat is locked before driving. The seat angle can be adjusted in two different positions with the handle (2). The angle of the back can be adjusted by putting or removing washers under the bolt (3).



FRONT SEAT

#### CONNECTION OF ENGINE HEATER.

For heating the engine, you can connect an external heater as shown in fig. 11.



ENGINE HEATER  
CONNECTIONS



## MAINTENANCE.

Before driving:

Check that no fluid are leaking from radiator, engine, axles, and front wheel joints. Leaks must be repaired before driving.

Coolant:

Check the coolant level in the radiator. NOTE! There is a positive pressure in the radiator, so be careful when you open the lid when the engine is hot. If the fluid level is too low, add fresh water. The engine must be so warm, that the thermostat are open, so you can be sure that the cooling system are filled completely. Remember to check the fluids freezing point in the wintertime. The check must be carried out when the engine is warm.

Engine oil:

Pull the dipstick out on the right side of the engine and check the level.

Refill if needed

Never allow the level to exceed the upper mark on the dipstick.

Fuel:

Make sure that there is enough fuel in the tank, and that the jerrycans are filled. Stop the engine while filling, use a funnel when refueling from a jerrycan.

Tyre pressure:

Carefully check the tyres, and their inflation.

Snowchains:

Snowchains must be properly mounted and tied. If they are tied too tight, they will damage the tyre, and damage the body and cause unnecessary noise.

Note that the braking distance will be increased, when using snowchains.

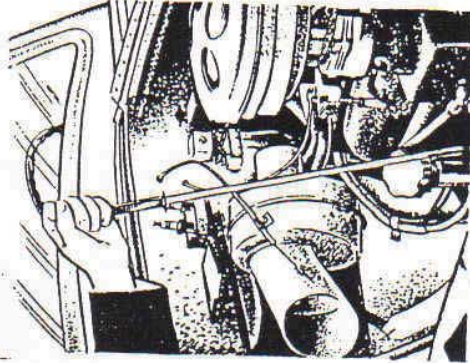
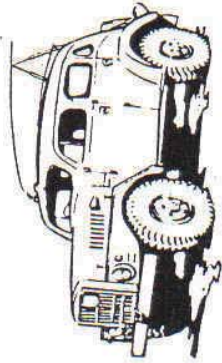

ENGINE OIL DIPSTICK



WINDOWS, MIRRORS AND REGISTRATION PLATES.

Check that the windows, mirrors and reg. plates are intact and clean.

LIGHTS.

Check that the light bulbs are intact, and there are no moist on the inside of the lampglass, and these are set correct. The headlightings must be removed to reach the adjusting screws for the headlights.

TURN SIGNALS, SIGNALHORN, WINDOW WIPERS, AND REAR MIRROR.

Check the turn signals, flashing must be at regular intervals. Change broken lightbulbs.

The signalhorn must give a loud tone. Check for short circuit or incoming dirt if the tone is weak.

The window wipers must work correctly.

Check that the rear mirrors are intact, clean, and set correct.

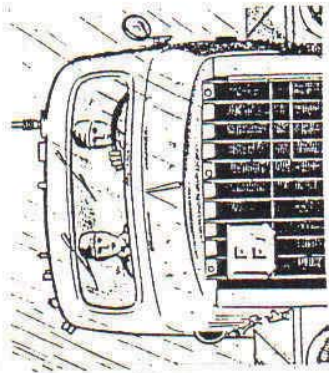

CLUTCH.

The clutch must be allowed to go down 25-30 mm before you feel any resistance in the pedal.

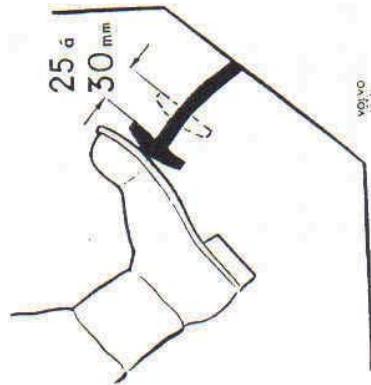



#### GAUGES (OILPRESSURE, CHARGING).

Check the oil pressure when the engine is started, the pressure should be 1,5-2,5 kg/cm<sup>2</sup> at a normal idle speed, when the engine is warm.

The generators charging controllamp is out when the generator is charging, but it might light or flash in low rpm area. This is quite normal.

#### EQUIPMENT AND CARGO.

Be sure that all equipment are well tied and stowed, and that the safety catch on the tow hook is in place.

Check that the trailer is towed securely.

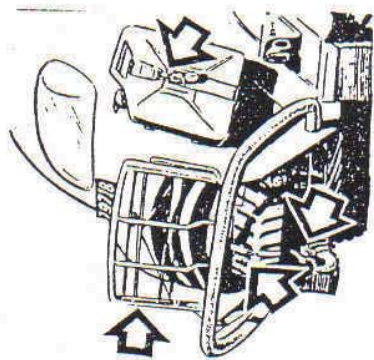
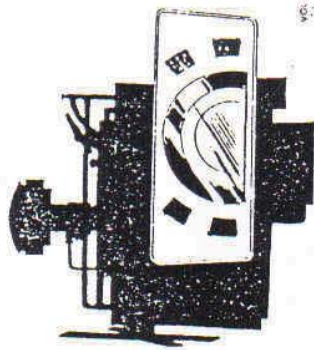

#### BRAKES.

The parking brake should start working in the third or fourth notch.

Check that the parking brake lock is engaged before leaving the vehicle.

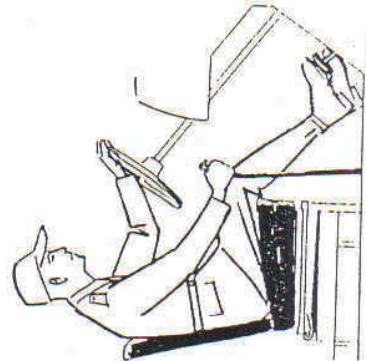



SPECIAL MAINTENANCE.

Weekly maintenance are marked with an A  
Monthly with a B.

A. Engine, manifolds, exhaust pipe, mufflers, and tailpipe. Check, while the engine is running, that no leaks are accured, caused by any loose bolts or torn gaskets. Feel with your hand and listen, especially at connections, and at the bottom part of the muffler. Check that all bolts are tightened, and that no exterior damage has occurred.



A. Listen to the engine at different rpm's, and in idle rpm. Noises like valves knocking and other knockings must not occur.

Idle speed adjusting must only be performed on the idler screw on the carburetor.

A. Oil filter, oil pan, valve cover, and oil pipes.

Check that no leaks have occurred. If necessary, wipe off the engine, and restart before checking. Especially note the fuel pump gasket, the rear engine bearing, plugs, and connections.

A. Fuel system, air cleaner.

Check that the air cleaner is properly tightened.

Loosen the wingnut(1), lift the lid and take out the filter cartridge(2), and check the oil level(3). If the bottom part are dirty, you must clean the filter cartridge, and new oil must be added.

B. Carburetor.

No leaks must occur at the carburetor and fuel pipes, check that all bolts and nuts are properly tightened.

B. Hand- and foot gas, choke.

Check that all the rods are free to move, and that they are intact.

The handgas and choke wires shall travel smoothly, and must not be bent sharply. Be sure that everything are tightened properly.

B. Fuel pump and fuel filter.

Check that gaskets, connections, and pipes are not leaking, and that the pump and filter are properly fastened.

Clean the fuel filter if needed, by the following instructions.

Fuel pump filter:

Loosen the screw(1), and take the clamp(2) aside. Remove the glassbowl(3) and the filter(4).

Wash the parts in clean fuel, and blow them clean with compressed air. Be sure that the gasket(5), and glassbowl are intact, if not, new one must be installed. Put the parts together again, and pump the filter full with the handpump(6).

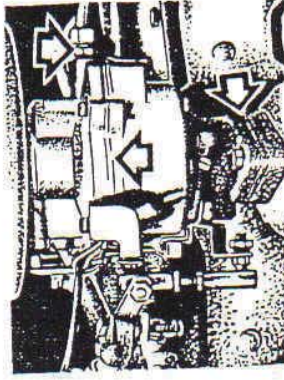
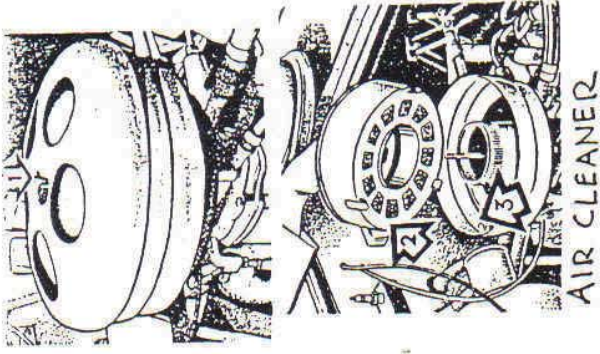



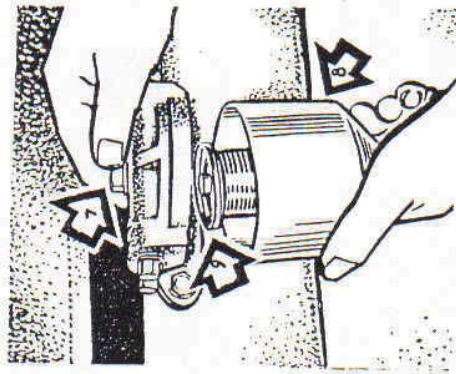

Seperate fuel filter:

Loosen the screw(7) in the lid, and pull the container down(8). Remove the cartridge(9), and clean it carefully in clean fuel, dry with compressed air. Make sure that the brass discs are intact. Clean the container from sludge, dry with compressed air. Check the gaskets, it is very important that the gasket in the lid is in perfect condition, so that air will not enter the system. Put the parts together again, and make sure that the lid gasket is straight during assembly.

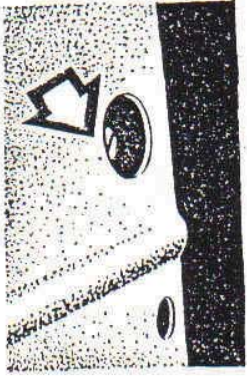

**B. Fuel tank with cap and pipes.**

Check that the tank and the pipes are not leaking, and that everything are properly fastened. Drain the tank when needed by opening the bottom screw. Draining is important in the wintertime.

**A. Electrical system, battery with wires.**

The battery is placed under the rear passenger seat. Clean batteries, pole clamps, and battery box with an alkaline solution, or clean water on a brush. Check that the cell lids are intact, and the bleeding holes are free from dirt. Refill with distilled water, if the level is less than 10 mm above the plates. Grease the pole clamps with vaseline, and make sure that both pole clamps and batteries are properly fastened.

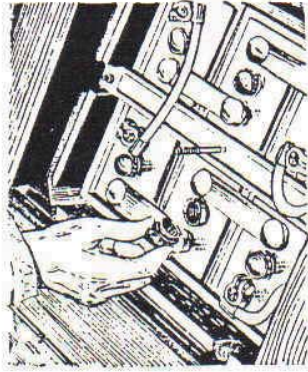



B. Starting engine with cables:

Check that the starting engine and the wires are properly fastened, and that the wires are free from coatings.

B. Generator with wires.

Check that the generator and the wires are properly fastened.

Check the driving, and that the fan belt are properly tightened.

A. Distributor with wires:

Check the distributor on the outside and clean it if necessary.

Check the wireconnections.

Check the distributor cap for cracks.

A. Sparkplugs, coil with interference stocking and wires.

Check that the sparkplugs are properly tightened.

Check that the sparkplug wires are properly put on.

Clean the sparkplugs, coil, and the wires.

Check that the wire insulation and the interference stockings are not damaged.

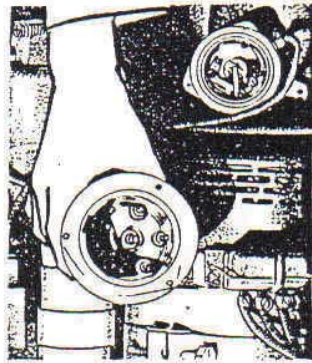

DISTRIBUTOR



A. Lights, turn signals, signal horn, and windshield wipers. Check that the lights and beamthrowers are working, and that they are intact, correct set, and properly fastened. If any beamthrower needs adjusting, first loosen the beamthrower clamp, and bend it forward, then turn the screws(2) for vertical, and the screws(3) for horizontal adjustment. To disassemble the beamthrower, remove the clamp (1).

If the lightbulb is to be replaced, never touch the glass with your fingers. Use the bulbs carton.

Check that the turn signals are working, and that the bulbs are intact.

Check the signal horns tone, and its connections.

Check that the windshield wiper blades are intact, and that the contact face is correct.

B. Visible wires: (in common)

Check that the wires are properly tightened, their insulation are not damaged, and that they are not near any sharp edges.

Check that no fuses are burned.

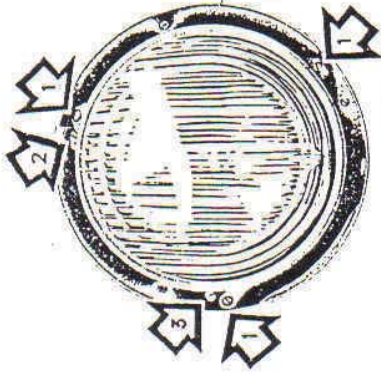
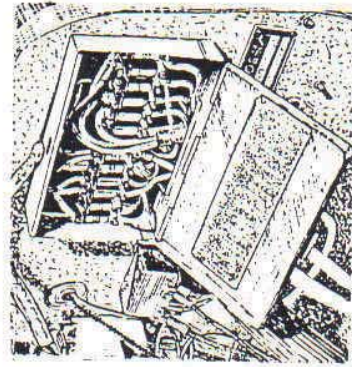



B. Cooling system, radiator curtain.

Check that the curtain is properly fastened, and that you can operate it from the drivers seat.

B. Radiator, hoses, hose connections, pipes, and bleeding cocks.

Check that no leaks have occurred at the radiator, pipes, hoses, and connections. At the same time, check that all the bleeding cocks are tightened.

Check that the radiator, and hose connections are properly tightened. The radiator lid must be tight, and its gasket must be intact. Make sure that the overflow pipe is free from dirt.

Wintertime: Check the coolants freezing point.

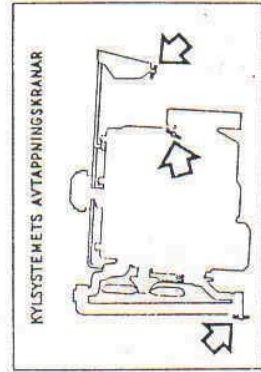
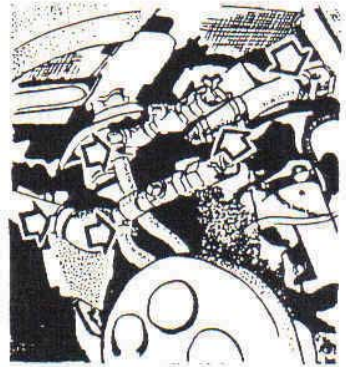

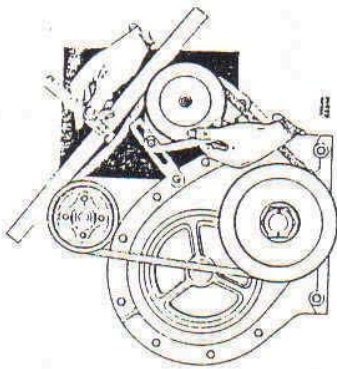

A. Fan.

Check that the fan belts are intact and properly tightened. They should be allowed a gap at 10 mm between two pulleys. The belts are tightened by loosening the generator is moved, so that correct belt tension is achieved, and the generator is tightened again. Check that the fan blades are not damaged, that they do not hit anything, and that the fan is properly tightened.

B. Water pump.

Check that the water pump is not leaking, and that it is properly fastened.



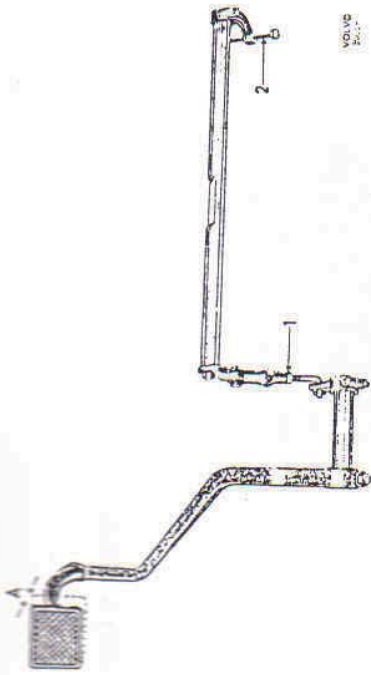

B. Transmission, clutch with linkage

Check the engagement, and the clearance (A). It should be between 25-30 mm. The clutch must not skid or jerk. Noises must be heard when the engine is running with the clutch disengaged. The clearance is adjusted with the adjusting screw (2) and the connecting rod (1). To adjust the clearance, first loosen the locknut, then turn the adjusting screw backwards, if the clearance is to be increased, or forward if the clearance is to be decreased. Adjust at the same time the connecting rod, so that the clutch pedal reaches its top position.

B. Gearboxes with gearsticks.

Check that the gearbox and dist. gearbox are properly tightened, and that the gearsticks can be operated without any difficulties, and no noises are heard. Check if there are any clearance at the in- and output axles, and the size of it. Check the oil level, if there has been leaks, check the drain plugs and gaskets.

B. Transmission shaft with universal joints and flange connections.

Check the transmission shafts for clearance in the universal joints, and that there are no loose bolts in the flange connections.

B. Front- and rear gear, and steering rod.

Check that all nuts and bolts in the front- and rear gear are properly tightened. Check the oil level, if there has been leaks, check the drainplugs. Check that the steering rod is straight and that it is properly tightened.



B. Drive axles and frontaxle joints.

Check that the drive axles flange bolts are properly tightened. Check that no exterior damage have occurred. Check the oil level if there have been any leaks.

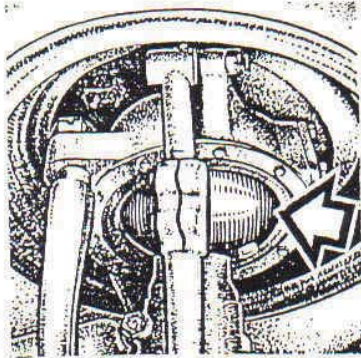

B. Diff. locks with operating handles.

Check that the diff. locks are working, and that the controllamps are intact. The handles must be undamaged and travel smoothly.

A. Tyres, wheels (Sparewheel).

Check the tyre pressure .

Check the tyre valves if the tyre pressure is low. Allvalves should be equipped with a dustcap.

Check the tyres for damage and wearing. Inspect the wearing surface for rocks

Check that the wheel nuts are properly tightened. Tighten the wheel nuts as shown in the picture.

B. Springsystem, chassis frame.

Spring leaves, spring clamps, and spring bolts.

Check that the springs are clean, free from cracks, and that they are not displaced.

Check that the spring clamps are tightened.

Check the lubrication and wearing at the spring bolts.

B. Shock absorbers.

Check that the shock absorbers are properly tightened, and that no fluid have leaked out.

B. Chassis frame.

Check the chassis frame for cracks, and the riveted connections for damage.

B. Steering gear.

Check the oil level in the steering gear house, and that it is properly fastened. Turn the steering wheel from side to side to check the clearance.



- A. Steering arm, linkage, linkage arm, and parallelrod.  
Carefully check that everything are properly fastened, and there are no clearance in the joints  
Check that nothing are out of shape, and everything are well greased.
- B. Front axle.  
Check the front axle, for clearance in the wheel bearings and axle ends. Check that all the bolts  
and nuts are properly tightened. Inspect the front axle for damage or other deformations.
- B. Brake system. Parking brake with lock and linkage.  
Check the parking brakes function, its lock, and that the linkage are in good shape. Check that  
the fastening are in good shape, and all the bolts and nuts are properly tightened.
- A. Footbrake.  
Check that the brakes are pulling hard and evenly. Check the brake fluid level. Check the system  
for leaks. Check the pedals travel while braking. Check that the brake shoes are not scraping  
on the brake drums. (The shoes are scraping if the brake drums are hot after driving).

Cleaning the brakes.

- a. Loosen the wheelnuts and pull off the wheel. Now pull off the brake drum. If it is impossible to loosen it by hand, read the following instructions. (b-c)
- b. Slide the cover plate aside and insert the special tool (VOLVO-210058), or screwdriver in the hole and turn the adjusting wheel on the brake cylinder. To loosen the brake shoes, turn the wheel counter clockwise.
- c. Insert both trigger screws M10 x 1,5 and turn them, so that the drum will loosen.
- d. Clean the parts carefully using clean water. Grease the hub and the contact face between brake drum and wheel to avoid corrosion.
- e. Replace the brake drum and wheel.
- f. Adjust the brakes. Turn the adjusting wheel clockwise until the wheel is locked then loosen so much that the wheel can rotate.
- g. Bleed the system if needed.

B. Body.cabin.

- Inspect the body carefully and check that loose or damaged parts are tightened or replaced. Check that luggage carrier and clamps for spade, exhaust extension hose, axe, jerrycans, and sparewheel are intact
- B. Doors, hatches, locks, window hoists, windows, rear compartment and hood locks. Check that the doors and their hinges, handles, and locks are intact and working. Loose screws and nuts should be tightened.
  - Check that the window hoists are working, and the windows and seals are intact.
  - Check the rear compartments and hoods hinges and locks.
  - B. Inside upholstery, seats. Check the upholstery and clean it. Clean the floor. Check that the seats are properly fastened.

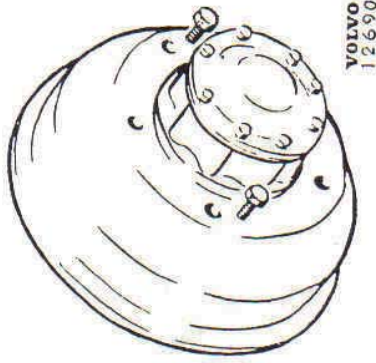
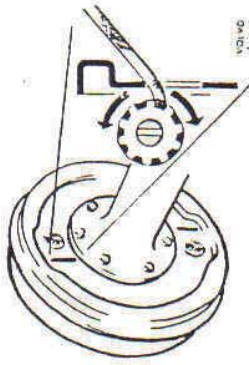



B. Bumpers, mudguards, footsteps, and grillguard.

Check that the bumpers, mudguards, footsteps, and grillguard are undamaged. Make sure that they are properly fastened.

B. Drag devices.

Check that the drag devices are intact and properly fastened.

Make sure that the lock pins are secured with a chain, and that the hooks bearings are greased.

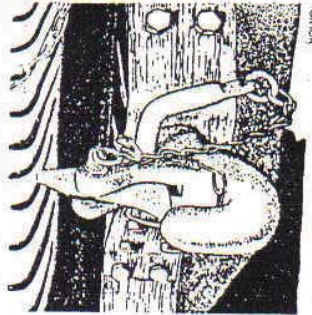
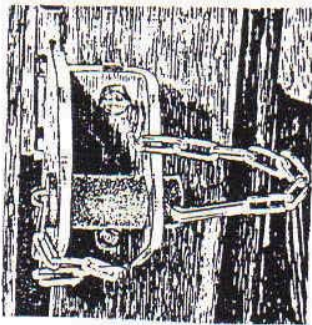

B. Heater with pipes and handles.

Check that the heater is working and that all screws and nuts are properly tightened.

All hose and pipe connections must be tight. Check the system for leaks.

Check that the handles are working, and that they are properly fastened.

The following are not week-or monthly. They are performed when there is a need for it.

Engine, engine room

Clean the engine and the panels around it.

Crew-and luggage compartments.

Clean the seats, floors, glove compartment, and rear compartment. Outside the vehicle.

Clean the vehicle on the outside. Repair scratched paint. Under the vehicle.

Wash the bottom of the vehicle with water. Clean the brakes.



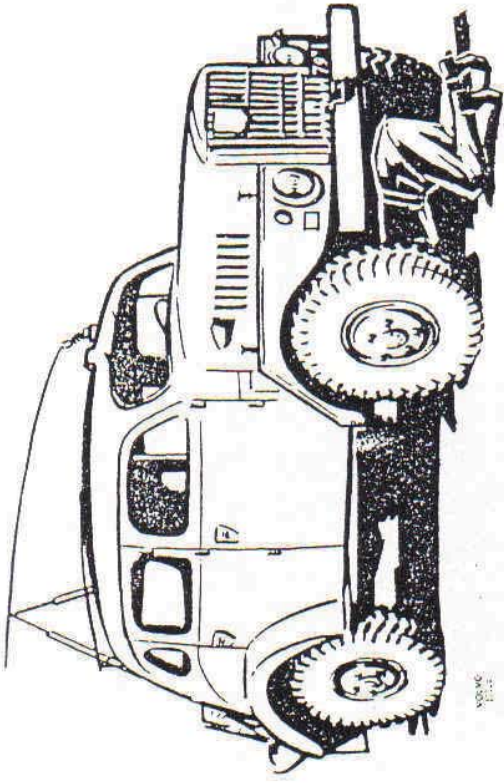

**Lubrication:**

The lubrication is the most important part of the maintenance. Make sure that it is properly performed.

The grease nipples, oil cups, and the surfaces around the filling holes should be cleaned before filling to avoid dirt in the oil or grease. Faulty nipples should be replaced.

Make sure you use the right oil in the right place!

1. Spring clamps.

Eight grease nipples, four on each side. Grease until it comes out on the inside of the clamp.

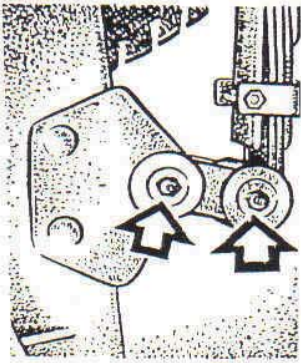

2. Rear axle gear.

Remove the level plug every 2000 km and check the oil level. Oil change should be performed every 1000 km, or every second year.

The oil should be changed just after driving, when the oil is still warm and lean.

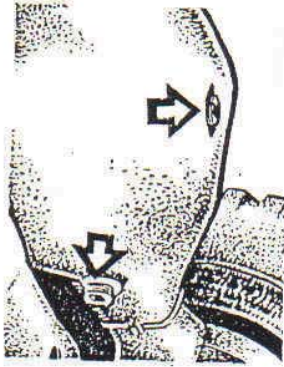

3. Wheel bearings.

Lubrication must only be performed by a mechanic.

4. Universal joints.

Seven grease nipples, three between the dist. gearbox and front axle, and two on each joint. Fill until it comes out of the pipe and on the inside of the bearings.

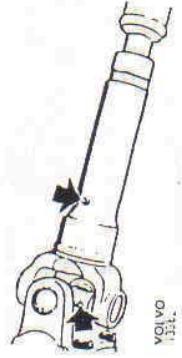

Volvo  
1971



5. Spring bolts.

Four grease nipples, two on each side. Grease until it comes out on the spring.

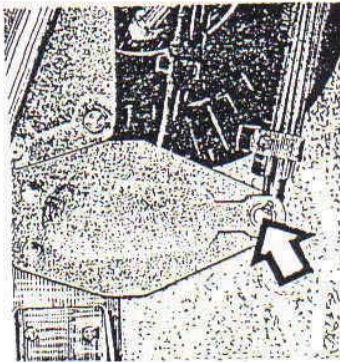

6. Universal joint.

Three grease nipples, one on each joint, Grease until it comes out on the inside.

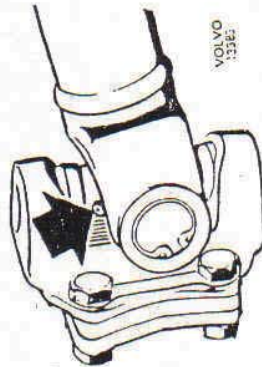

7. Clutch axle.

Two grease nipples, one or two strokes with a hand pump.

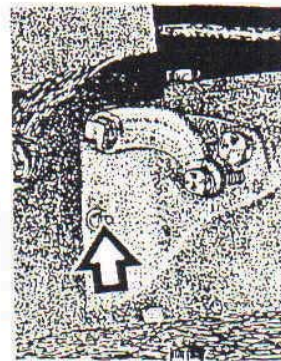
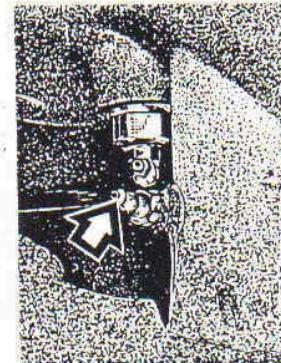

8. Brake system, main cylinder.

Check that the main cylinder is nearly filled. (1cm below the filling hole)

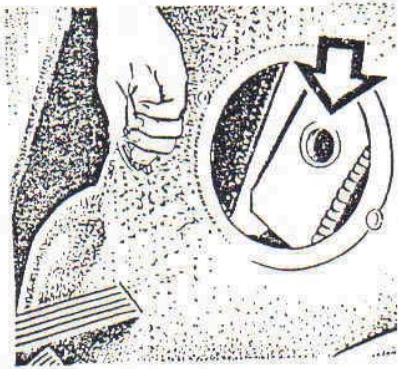

9. Pedal axle.

One grease nipple, grease until it comes out between pedals and axle.

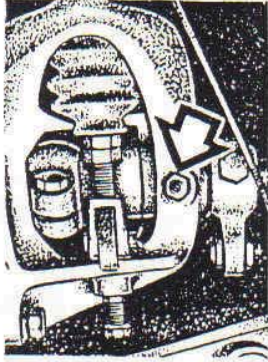

10. Oil filter.

Loosen the bleeding screw on the filter container and drain the oil every 2000 km-in very dusty areas every 1000 km together with oil change. (only models before v.i.n. 220).

Change the filter cartridge every 10000 km. Loosen the screw that holds the lid in place, and the cartridge can be pulled out. Before checking the oil level, run the engine for a few minutes so that the filter can be filled.





11. Distributor.

Turn the grease cup halfway round. Fill when needed with BOSCH-Ft v 26 grease or similar. Lubricate the contact cam every 10000 km with a few drops of engine oil.

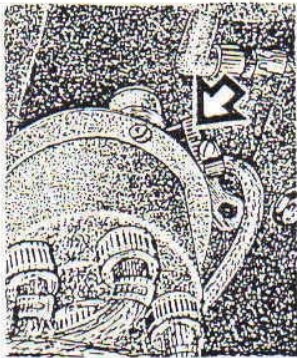

12. Steering rods.

Two grease nipples, grease until it comes out at the joints.

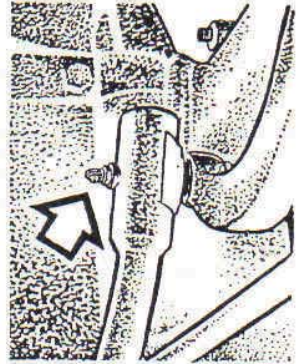
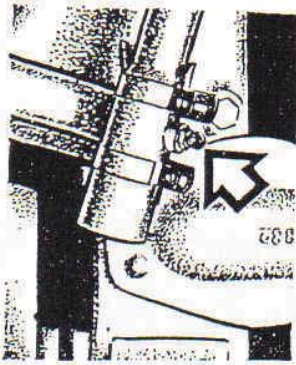

13. Front wheel joints.

Loosen the level plug, and check the oil level in the front wheel gear.

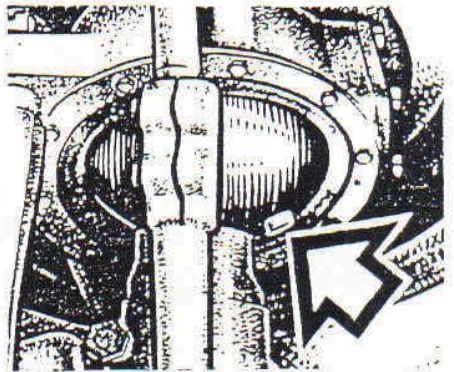

14. Spindle bearings.

See part 11 for lubrication.

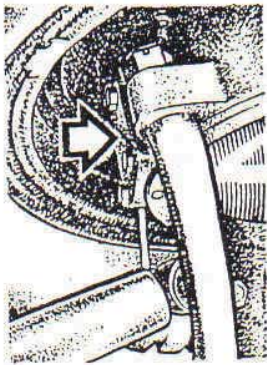

15. Parallel rod.

Two grease nipples, grease until it comes out of the joints.

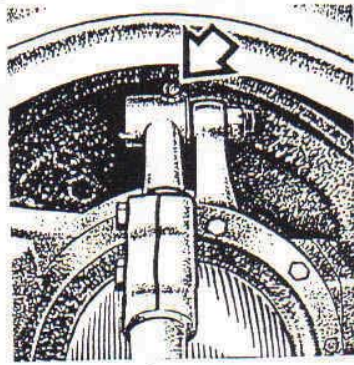

16. Steering gear house.

Check the oil level and add if needed. The house should be filled at all time.

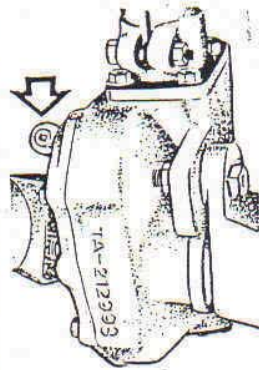

17. Cooling pump.

One grease nipple, not more than two strokes with a handpump.  
**NEVER USE A HIGH PRESSURE PUMP!**

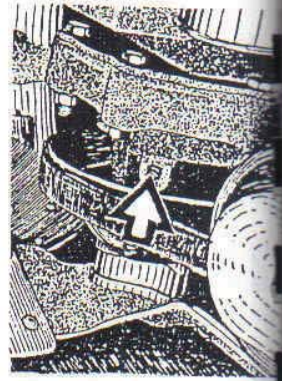



18. Remove the level plug every 2000 km. Change oil every 10000 km, or at least every second year. The oil should be drained just after driving, when the oil is still warm.

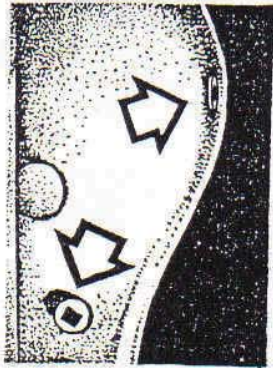

19. Air filter.

Clean the air filter every 2000 km, or every 1000 km if the vehicle are driven in dusty areas.

Clean the filter after the following instructions:

- Loosen the wing nut(1) and lift the lid and the filter cartridge(2). Loosen the container.
- Clean all the parts in kerosene.
- Dip the filter cartridge in engine oil. Allow the oil to drip off.
- Put the container in place and refill to level mark(3). Use engine oil.
- Put the cartridge in place and tighten the lid.

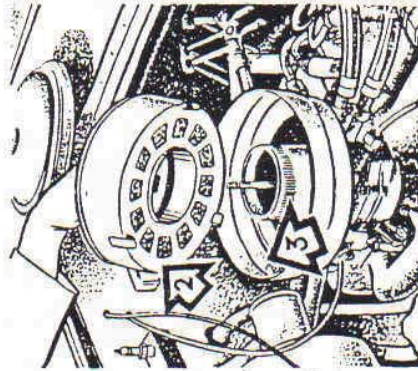
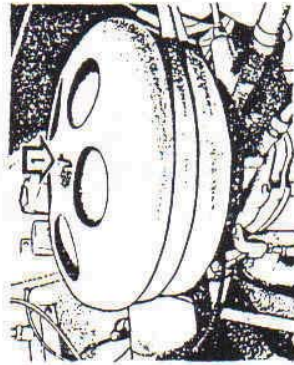

20. Oilpan.

Change the oil every 2000 km, loosen the drain plug in the bottom of the oilpan. The engine must be warm when the oil is drained.

Refill through the filling pipe on the right side of the engine. Clean the filter in the lid.

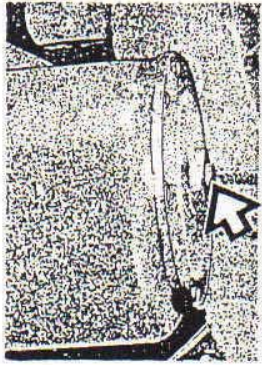

21. Releasing lever bearing.

One grease nipple, not more than 1-2 strokes with a hand pump.

NEVER USE A HIGH PRESSURE PUMP!

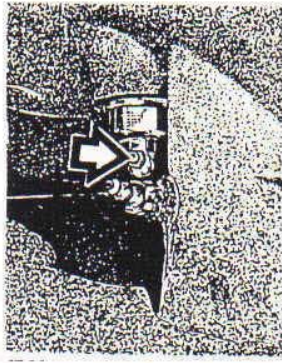

22. Parking brake linkage.

One grease nipple, grease until it comes out between link and axle.

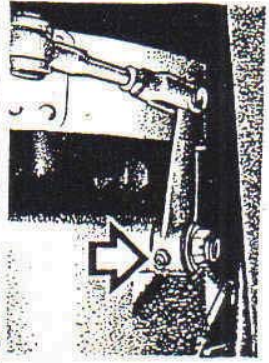



23. Remove the level plug and check the oil every 2000 km. Change the oil every 10000 km, or at least every second year. The oil should be changed just after driving when it is still warm.

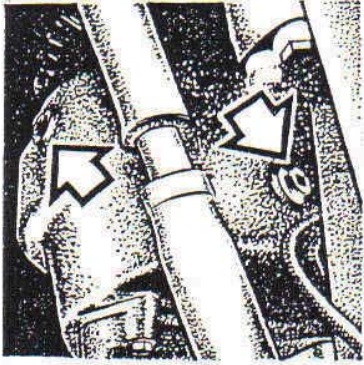

24. The same as 23.

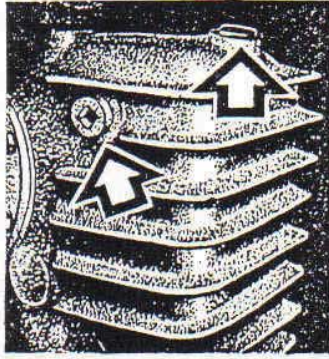

25. Speedometer wire. Unscrew the wire at its upper end and fill a few drops of engine oil into it.

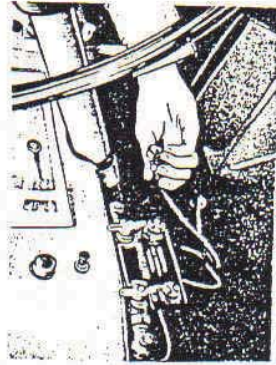

26. Drag hook.

Two grease nipples, grease until it comes out at the bearings.

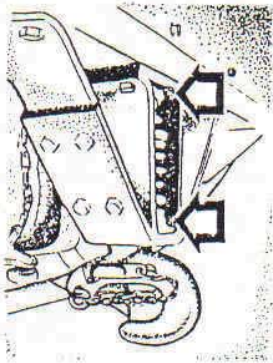

27. Gas lever, locks, hinges, and other.

Put a few drops of engine oil in all movable parts of the gas lever every 10000 km. Doorlocks and key holes should be lubricated with silicon oil.

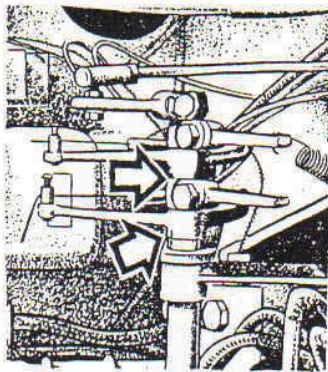



pos.nr.	item	type	volvo part nr
1	Beamthrower insert	ROBO-B24/165	77804
2	Bulb 45/40W,12V	OSRAM7351	182031
3	Bulb 1,5W,12V	OSRAM 3796	19906
4	Blackout light	ROBO-B 95/1	76728
5	Bulb 15W,12V	OSRAM 6451	182045
6	Plug 4 poled	VOLVO	304317
7	Diff.lock switch	VOLVO	713622
8	Yellow diff.lock lamp	ROBO-B 49/2	76736
9	Sparkplug	AC-45 COM	406163
10	Signal horn	BOSCH-HO/FSA 12/3	77705
11	Relay	BOSCH SH/SE 11/2	77708
12	Spark plug wire	BOSCH-T 7 LA	76539
13	Shield cover	BOSCH-NFR 11/2	
14	Shield cover	BOSCH-EM/WAR 5/10	76538
15	Distributor cap	BOSCH-ZV/JAM 6 L 1	76536
16	Coil	BOSCH-ZS/KAM 12/1	76537
17	Noise filter	BOSCH-EM/SB 6/1 or EM/S5/1	48154
18	Dropping resistor	BOSCH-ZVJ 11/1	76566
19	Charging regulator	BOSCH-RS/KK or KM600/12/1	76565
20	Fuse	BOSCH-WSG 512/7X, 80A	11450
21	Generator	BOSCH-LJ/GQL600/12-1400 R 10	77706
22	Ventilation coat	BOSCH-LJDE 3/2	76534
23	Noise filter	BOSCH-EM/SB 75/1 or EM/S 75/1	48162
24	Starting engine	BOSCH-EJD1,8/12R28	76535
25	Pos.lamp	M 2767-701010	714219
26	Bulb 3W,12V	OSRAM-6439	182044
27	Switch	BOSCH-SH/TZ 1/1	77593
28	Plug 1 poled	VOLVO	182009
29	Noise condenser 0,45 micro F	BOSCH-EMKO 19Z3Z	77612
30	Heater engine	ELUX-KS 3442/212	79622
31	Switch	BOSCH-RS 8065/0	76725
32	Roof lamp	OSRAM-7530	92016
33	Bulb 15W,12V		11489
34	Brake light switch	BOSCH-SSH 38 L 23	62309
35	Reverser,turn signal	ROBO-B 49/2	65575
36	Yellow cont.lamp,turn signal	TUSOL-143 S45	76736
37	Turn signal relay	ROBO-B 49/1	714113
38	Red cont.lamp,charging		76735
39	Start switch		72579
40	Ign. lock	BOSCH-SH/ZS 4/1	76533

L A I E MODEL

pos.nr.	item	type	volvo part nr
1	Beamthrower insert	ROBO-B/165	76831
2	Bulb 45/40W,12V	OSRAM-7351	182031
3	Bulb 1,5W,12V	OSRAM-3796	19906
4	Blackout light	M 2767	625001
5	Bulb 15W,12V	OSRAM-6451	182045
6	Plug,1 poled	VOLVO	182009
7	Signal horn		77705
8	Relay	BOSCH-HO/FSA 12/3	76968
9	Spark plug wire	BOSCH-SH/SE 20/2	233456
10	Shield cover	BOSCH-NKA 114/1 V8	233467
11	Shield cover	BOSCH-NFR 11/2	76538
12	Distributor	BOSCH-EM/WAR 5/10	76536
13	Coil	BOSCH-ZV/JAM 6AL 1	76537
14	Noise filter	BOSCH-ZS/KAM 12/1	48154
15	Dropping resistor	BOSCH-EM/SB 6/1	76566
16	Charging regulator	BOSCH-ZWJ 11/1 Z	76865
17	Fuse	BOSCH-RS/WA 600 12/1	11450
18	Generator	BOSCH-WSG 512/7X, 80A	76732
19	Cover	BOSCH-LJ/GQL 600/12/1400 R 10	233167
20	Noise filter	ROBO-B 472	76522
21	Starting engine	BOSCH-EM/SB 75/1	76535
22	Pos. light 12V	BOSCH-EJD 1,8/1,2 R 85	625035
23	Bulb 3W,12V	M 2767-701010	182049
24	Plug, 4 poled	OSRAM 6439	182037
25	Plug, 5 poled	ROBO-B 425	182060
26	Brake switch	BOSCH-WM/LA 5/1	319552
27	Diff.lock switch		713622
28	Yellow cont.lamp,diff lock	ROBO 49/2	76736
29	Dimmer	ROBO-B 487	233029
30	Switch	BOSCH-RS 8065	76725
31	Roof lamp		92016
32	Bulb 15W,12V	OSRAM-7530	11489
33	Ball joint lamp	Tc 87175	625063
34	Bulb 5W,12V	OSRAM-5007	182042
35	Fuel level transmitter	AC-SPHINX	307373
36	Turn signal 12 V	FIX-1245	714199
37	Blackout light reverser	Tp 24010	625000
38	Turn signal relay	BOSCH-SH/BVC 12/1	233751
39	Turn signal reverser	BOSCH-SSH 38 L22	65575
40	Wellow cont. lamp,turn signal	ROBO-49/2	76736



pos.nr.	item	type	volvo part nr
41	Noise condenser 0,45 microF	BOSCH-EMKO 19Z3Z	77612
42	Battery 6V 190Ah	M 2672 010010	28990
43	Jump start connection		
44	Switch	BOSCH-SH/T z 1/1	77593
45	Heater engine	ELUX-KS 3442/212	79622
46	Dimmer 20		714726
47	Lamp socket		82159
48	Bulb 3W,12V	PHIL-12910	19915
49	Fuel gauge	Combined gauge AC1565666	714114
50	Dropping resistor, 50 ohms	AB Radio supply Gothenburg	714328
51	Wiper engine	BOSCH-WS/WXC 12BS 302	233476
52	Wiper lever	BOSCH-WSHE 16Z 53 Z/2	72421
53	Noise condenser	BOSCH-EMKO 15Z 10 Z	233496
54	Red cont.lamp,charge	ROBO-49/1	76735
55	Dimmer,red	ROBO-B 486	233028
56	Start locks	BOSCH-SH/ZS 4/1	76533
57	Start switch		72579
58	Light seperator	Tp 24011	711917
59	Fuse plug	ROBO-B 949	190430
60	Fuse plug	ROBO-B 932	140301
61	Fuse 8A	BOSCH-WSG 501/1	11433
62	Blinder reverser	ROBO-B 642	233528
63	Light reverser	BOSCH-SSH 38 L 22	65575
64	Signal horn switch		
65	Blue cont.lamp,rear beam thrower	ROBO-49/3	76949
66	Wireless connection	Tc 18407	625051
67	Automatic fuse 20A	Tc 32067	625043
68	Voltage gauge	LME-VRB 15x17	714223
69	Hand light output	Td 16138	625042
70	Fuse box	BOSCH-SEA 72/1	140320
71	Connection box	Tc 18226	625032
72	Fuse 60A	Tc 32004	625037
73	Rear light	BOSCH-Q 0 B 127	76839
74	Rear beam thrower	BOSCH-LE/RA 3/2	77624
75	Bulb 25W,12V	OSRAM-7582	190591
76	Reg.plate light		93886
77	Rear pos.light	M 2767-711010	625034
78	Distributor box	Tc 18567	625030

The wire area are 1,5 mm<sup>2</sup>, if nothing else are printed.  
Connections for pos nr 37: I=2+1, II=0, III=2+5 and 3+4.

EARLY MODEL

pos.nr.	item	type	volvo part nr
41	Light seperator 2 poled 2way	CUTLE8372/K8	714696
42	Fuse	BOSCH-WSG 501/1 Z	11433
43	Fuse box for 6 fuses	ROBO-B 933	140302
44	Fuse box for 6 fuses	ROBO-B 932	140301
45	Foot reverser		307785
46	Light reverser		89104
47	turn signal	FIX 1245	714199
48	Signal horn switch		
49	Black out light reverser	ROBO-B 514	76727
50	Ball joint lamp	Tc 87175	713825
51	Bulb 5W,12V	OSRAM-5007	182042
52	Battery 190Ah,6V	M 2672-010010	28990
53	Jump start connection	VOLVO	713723
54	Lamp socket		82159
55	Bulb 3W,12V	PHIL-12910	19915
56	Rheostat switch 20		714726
57	Fuel level transmitter	AC-SPHINX	307373
58	Fuel gauge	Combined gauge AC-1565666	714114
59	Dropping resistor 50 ohms	AB Radio supply Gothenburg	714328
60	Wireless connection	Tc 18407	88970
61	Voltage gauge	LME-VRB 15x17	714223
62	Automatic fuse	Tc32067	88977
63	Fuse box	BOSCH-SEA 72/1	140320
64	Hand lamp output	Td 16168	87676
65	Connection box	Tc 18226	88991
66	Rear beam thrower	BOSCH LE/RA 1/3	77624
67	Reg. plate light	VOLVO	93886
68	Stop-and back up light		315838
69	Bulb 10W,12V	OSRAM-6411	182039
70	Pos rear light	M 2767-711010	714220
71	Part of plug 4 poled		304317
72	Blue cont.lamp,rear beam thrower	ROBO-49/3	76949.

The wire area are 1,5 mm<sup>2</sup>, if nothing else are printed.  
 Connections for pos nr 49:  
 I=2+1  
 II=0  
 III=2+5 and3+4





# KOPPLINGSCHEMA FÖR DET ELEKTRISKA

Senare utförande  
LATE MODEL

